

Introduction

Diaphragm Valves proved to be the answer to many process engineers' greatest desire of reliability at an acceptable cost of ownership. Of simple and reliable design, diaphragm valves offer secure operation with full leaktight at the plant. The maintenance, when required, is limited to the replacement of the diaphragm, the bolted bonnet design permits to dismantle the valve without removing the valve body from the pipe work.

The body seatless design eases the internal lining, which opens a broad range to inexpensive options to process engineers when selecting materials resistant to corrosion and abrasion duties. Conventional isolating valves would demand expensive exotic materials to resist the effects of severe corrosion whereas a duly lined iron based material can do the job.

DIAVAL portfolio clearly meets the requirements of modern industrial processes and the needs of all engineers. Through constant product development and own polymer research technology, **DIAVAL®** Diaphragm Valves are a reliable alternative to existing costly and expensive to maintain conventional valves.

DIAVAL INTERNATIONAL manufacture one of the largest Diaphragm Valves portfolio comprehensive of body linings, diaphragm grades and actuation currently available in the international market. Your **DIAVAL®** Team is available to guide you along a great cost saving experience.



DIAVAL® range of superior design and major cost saving benefits, for secure and full leaktight operation under the most severe circumstances.

The **DIAVAL®** range is totally interchangeable with other diaphragm valves in the market thus easing the plant choice.

Valve stroke Indicator; a yellow position indicator gives clear and positive valve position from any angle.

Greased for life valve spindle; spindle chamber incorporates a grease reservoir that lubricates the spindle along operations thus avoiding valve spindle jamming. Sealed bonnet arrangements available for toxic and hazardous fluids.

Valve stroke stopper; the bonnet design prevents over closure of the valve thus avoiding early diaphragm rupture.

Ergonomically Design Hand wheel; great comfort and ease of operation. Other operation options such as actuators, padlocks, interlocking, extended spindle and others are available from **DIAVAL®**.

Self draining; Weir valves are self draining when installed at an angle of 20° above horizontal. ST and Full Flow valves are self cleaning with an unobstructed bore.

Diaphragms; wide range of diaphragm materials to meet the needs of today's industrial processes and standards. Resilient diaphragms provides 100% leak-tight shut off and isolates all bonnet parts from the line fluid.

Safety; Optional Sealed bonnet arrangements available for toxic and hazardous fluids, Interlocking arrangement, padlocking and flange sealing coating.

Linings; porous free chemically resistant linings designed to eliminate the need of expensive metals. Wide range of polymers and fluoropolymers available to match all industrial needs. Full face rubber lining removes the need for gaskets unlike spigot face lining.

Body end connections; flanged and screwed ends to meet all European, Imperial and American standards. Other end styles available for the aseptic range.

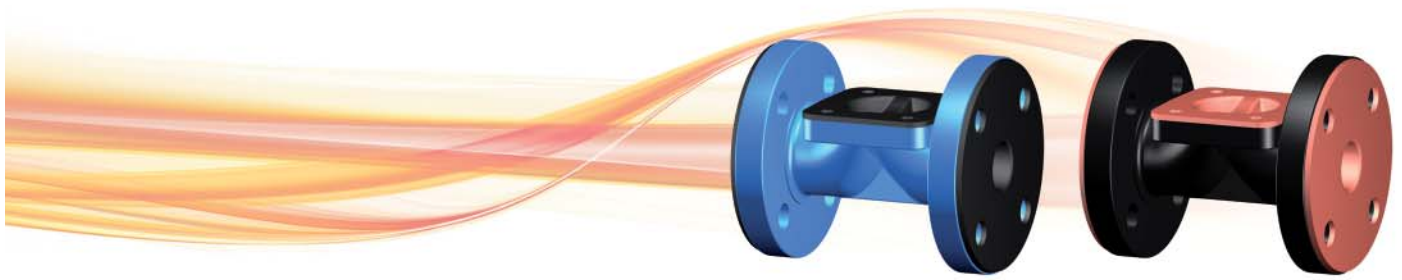

Application Guide - Lining

Lining Material	Applications
Hard Rubber - HR (Ebonite), sulphur cured, carbon black reinforced. Designated by a 'Sky Blue Spot' on end flange.	Used for inorganic salt solutions, dilute mineral acids, chlorine water, deionised and potable water.
Soft Natural Rubber-SR Polyisoprene, sulphur cured, carbon black reinforced. Designated by a 'white spot' on end flange.	Excellent abrasion resistance for powders, slurries such as clays, fly ash and cement products.
Soft Butyl Rubber-BR Isobutylene isoprene (IIR), sulphur cured carbon black reinforced. Designated by a 'Dark Blue Spot' on end flange.	Good for corrosive and abrasive slurries, dilute mineral acids and acidic slurries. Avoid chlorine and chorine solutions.
Soft Polychloroprene (Neoprene) Rubber Non-Sulphur cured carbon black reinforced. Designated by a 'Red Spot' on end flange. Hardness 65- +/- 5° Shore 'A'	Used on abrasives and minerals processing where small percentages of hydrocarbons are present.
Soft Hypalon® Rubber - (Chloro sulphonated polyethylene) Non-Sulphur cured carbon black reinforced. Designated by a 'Green Spot' on the end flange.	Chemical resistance to dilute / medium strength acids and chlorinated brine solutions and sodium hypochlorite
Linatex® Specially compounded "RED" coloured soft lining Hardness 45 +/- 5° Shore 'A'	Used for "WET" slurry applications

Speciality lining material for specific service

Halar® Co-polymer of ethylene and chlorotrifluoroethylene. Electrostatically applied coating.	Used for concentrated acids and salts containing hydrocarbons. Not suitable for dilute acids and inorganic salt solutions near to their boiling point. Minimal resistance to abrasive services.
Polytetrafluoro alkoxy-PFA® . Natural colour.	Most suitable for concentrated mineral acids at high temperature, aromatic and aliphatic and chlorinated solvents.
Ethylene tetrafluoroethylene-ET-FE® . Natural colour.	Most suitable for concentrated mineral acids at high temperature, aromatic and aliphatic and chlorinated solvents
FEP & PVDF	Consult Diaval@ (DN 350 under special manufacture)

Halar Coating

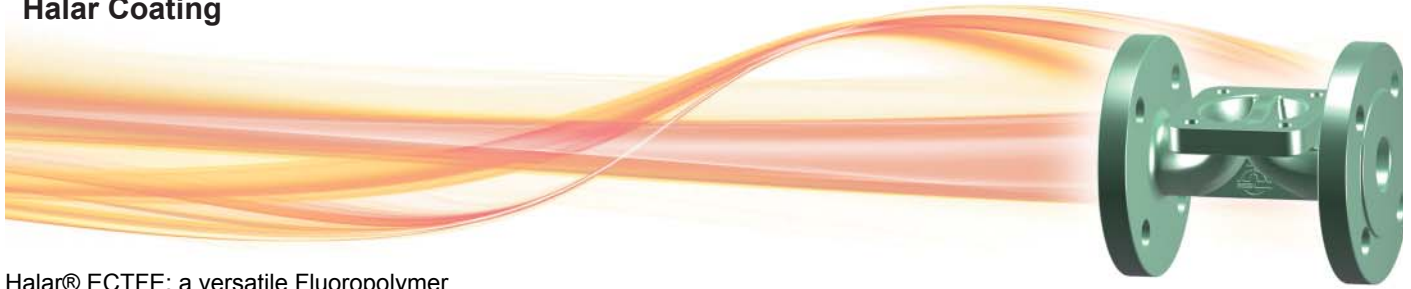

Halar® ECTFE; a versatile Fluoropolymer

Manufactured from ECTFE, is a melt processable Fluoropolymer. Halar® ECTFE is a partially fluorinated semi-crystalline polymer offering a unique combination of mechanical properties, thermal and chemical resistance with an outstanding ease of processability. It is a copolymer of ethylene and chlorotrifluoroethylene that brings advantages to valve application when compared to other Fluoropolymers. It is a very versatile polymer, available in all forms to meet processing needs. It offers excellent resistance to abrasion, harsh chemicals, and permeation. These characteristics have made of Halar® ECTFE a material of choice for several applications in the field of corrosion protection in the chemical industry. Halar® ECTFE is a high purity Fluoropolymer with a very smooth surface, which accounts for its extensive use in the semiconductor industry. Halar® meets the demands for fire-safe, non-fire propagating plastics. Halar® ECTFE powder coatings offer the greatest ease of processing, with the ability to be applied in high thickness when required.

Properties of Halar® ECTFE

Halar® offers a unique combination of properties especially as a coating and a liner. Halar Fluoropolymer coatings provide outstanding chemical resistance, good electrical properties, a broad-use temperature range from cryogenic to 150 ° C, and meet the requirements of UL-94 V-O vertical flame test in thicknesses as low as .007 (7mils). Halar® is resistant to strong mineral and oxidizing acids, alkalis, metal etchants, liquid oxygen, and essentially all organic solvents except hot amines.

Halar® ECTFE the DIAVAL® choice of Fluoropolymers

It is the preferable DIAVAL® choice over other Fluoropolymers such as PVDF, PFA or PTFE in example. For those applications exceeding the capabilities of other Fluoropolymers, Halar® can be evaluated before resorting to a fully fluorinated polymer, offering a compromise between the mechanical properties of a partially fluorinated plastic (like PVDF in example) and the chemical and thermal resistance which is typical of totally fluorinated polymers.

Halar® presents many other advantages over other Fluoropolymers as in example:

- Much better permeability properties.
- Smoother surface that precludes shedding of particles whilst avoid trapping.
- Environmental resistance properties.
- Thermal Properties and Chemical resistance properties.
- Electrical properties
- Mechanical Properties.

The graph shows how Halar® is rated in comparison to other Fluoropolymers in terms of permeation resistance to corrosive media at different temperatures.

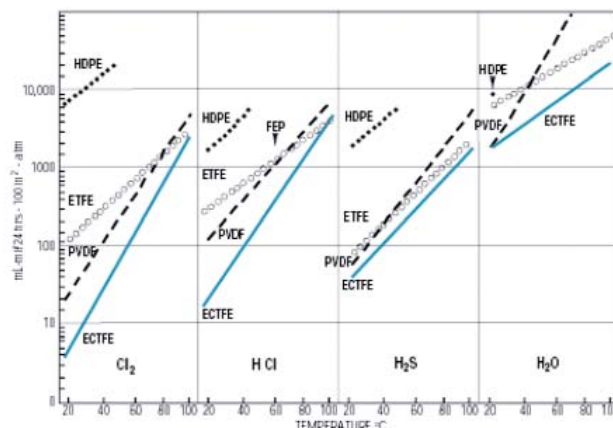

The electrostatic powder coated Halar® shows superior performance than conventional Fluoropolymers that can be shown with more information available in our Data Base on request.

Design Attributes

Weir Type Diaphragm Valves are linear motion valves, bidirectional, for stopping or regulating the flow of the service fluid when necessary. Valves close by turning the handwheel clockwise. Valves are bolted bonnet, seatless design, with a diaphragm as closure element, with rising handwheel. Valves are offered with a broad range of diaphragms and linings materials to resist to abrasion and corrosion duties. The valves are inexpensive and easy to maintain, being the optimal solution for a large number of applications.

Yellow position indicator, for clear and positive valve position from any angle

Nameplate incl. batch no. for full traceability

Closure Diaphragms; manufactured from elastomeric and fluorocarbon materials; provide 100% seating tightness in both directions while isolating the valve trim from fluid. Wide choice of polymers to satisfy any industrial application

Ergonomic and rugged rising handwheel

Grease reservoir integrated in the spindle chamber that lubricates the spindle along operations thus avoiding valve spindle jamming

Witness hole to detect leakage at diaphragm failure

Full rubber flange face in all rubber lined valves as standard

Porousless linings; provides the application engineer with a wide choice of linings of high chemical and abrasion resistance without need of expensive basic metal valve materials

Precise compressor plate; guide and operates the diaphragm up and down



Threaded version

Main Features

Valve design: EN 13397, EN 12516

Face to face length: EN 558 Series 1 (DIN 3202F1) or EN 558 Series 7 (BS 5156)

Valve end connections: - Flanged to EN 1092-2 type 21/B, PN10/16 (DN15-150)*; PN10 (DN200-300)

*(valves DN65 with 4 holes as accepted variant in standard)

option drilling to ASA150#

- Female threaded ends to ISO 228-1 (DIN 259-BSPP)

Marking: EN 19

Pressure Tests: EN 12266-1

Seat leakage rate: Rate A (full seat tightness in both directions)

Inside and outside primer paint layer black color for protection during storage and transport

Product compliant with Directive 2014/68/EU on Pressure Equipment (PED) and Machinery Directive 2006/42/EC

Options

Other materials, other ratings and connexions, pneumatic or electric actuator, limit switches, sealed bonnet, interlocking arrangement, padlocking or handwheel hood to avoid non-authorized operation. Please consult us

Main Duties / Limits of use

Liquids compatible with materials of construction, acc. to Directive 2014/68/EU Annex II tables 8 (group 1*) & 9 (group 2*) up to category I

Rubber Diaph.

- PS:16 bar DN10-50 (Art.4-Parr.3)
- PS:10 bar DN65-150 (Art.4-Parr.3)
- PS:6 bar DN200 (Art.4-Parr.3)
- PS:5 bar DN250 (Art.4-Parr.3)
- PS:4 bar DN300 (Art.4-Parr.3)

PTFE Diaph.

- PS:10 bar DN10-125 (Art.4-Parr.3)
- PS:6 bar DN150 (Art.4-Parr.3)

Combination of Body + Lining + Diaphragm determines the P-T limit of use of the valve

Questions referring to chemical resistance, please consult us

Observe also pressure/temperature limits on diagrams under

*Classification of fluids (group 1 or 2) acc. to Directive 2014/68/EU, Article 13

Bodies (Ductile iron)

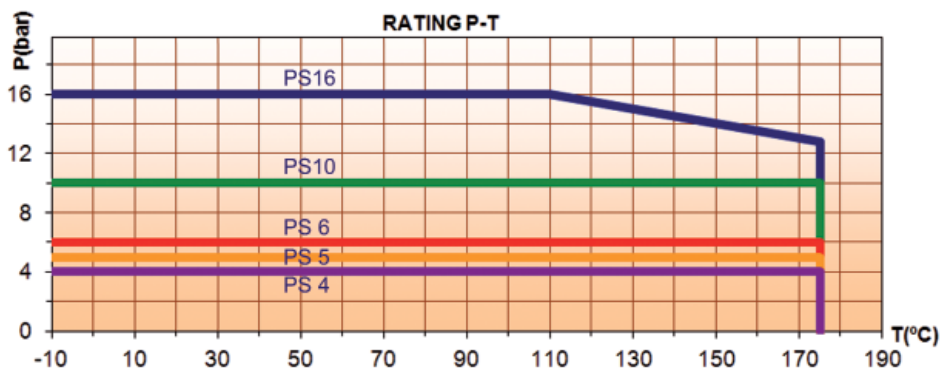

Linings

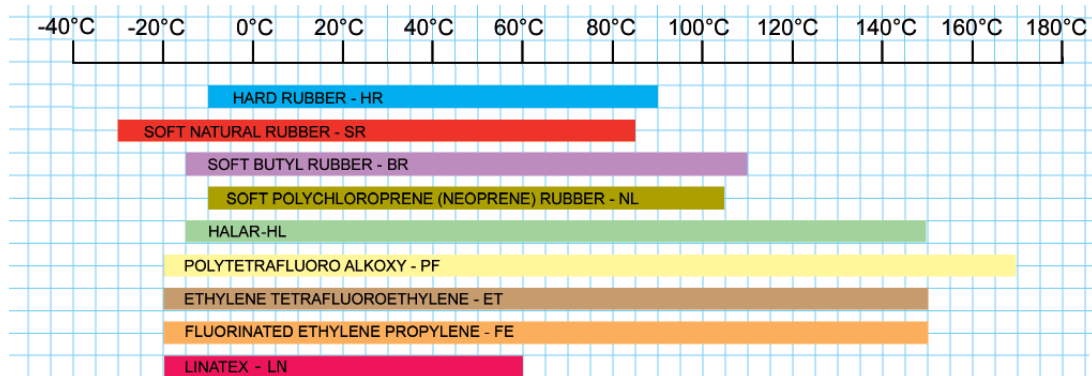

Diaphragms

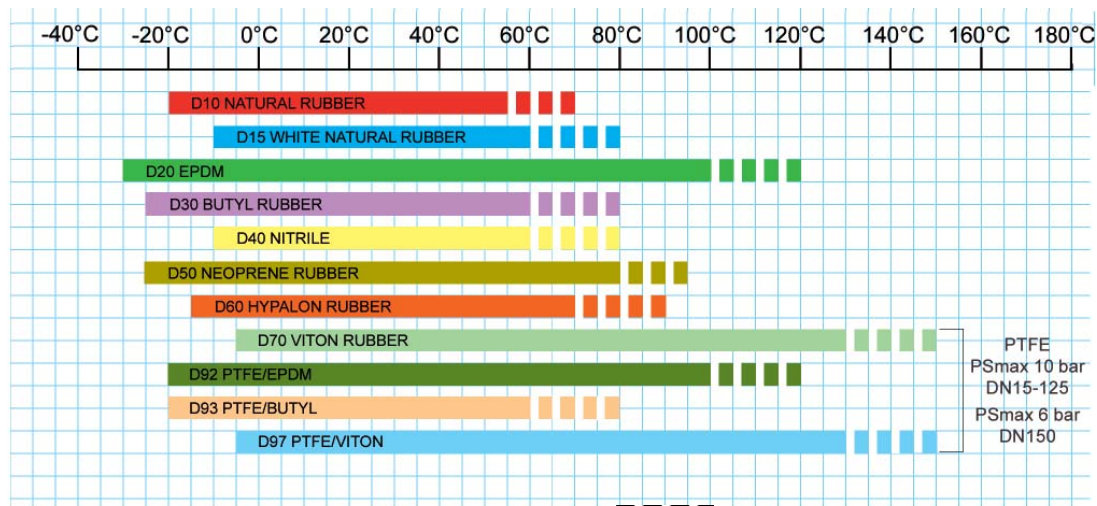

■ ■ ■ ■ Brief Peak Temperature (less than one hour)

Temperature Values are for neutral fluids and not plotted against any pressure parameter, the application engineer should consider that working limits are affected by the actual pressure / temperature relationship. Temperature values also depends on medium through the valve.

Halar® coated valves with flanged ends

Main Parts and Materials

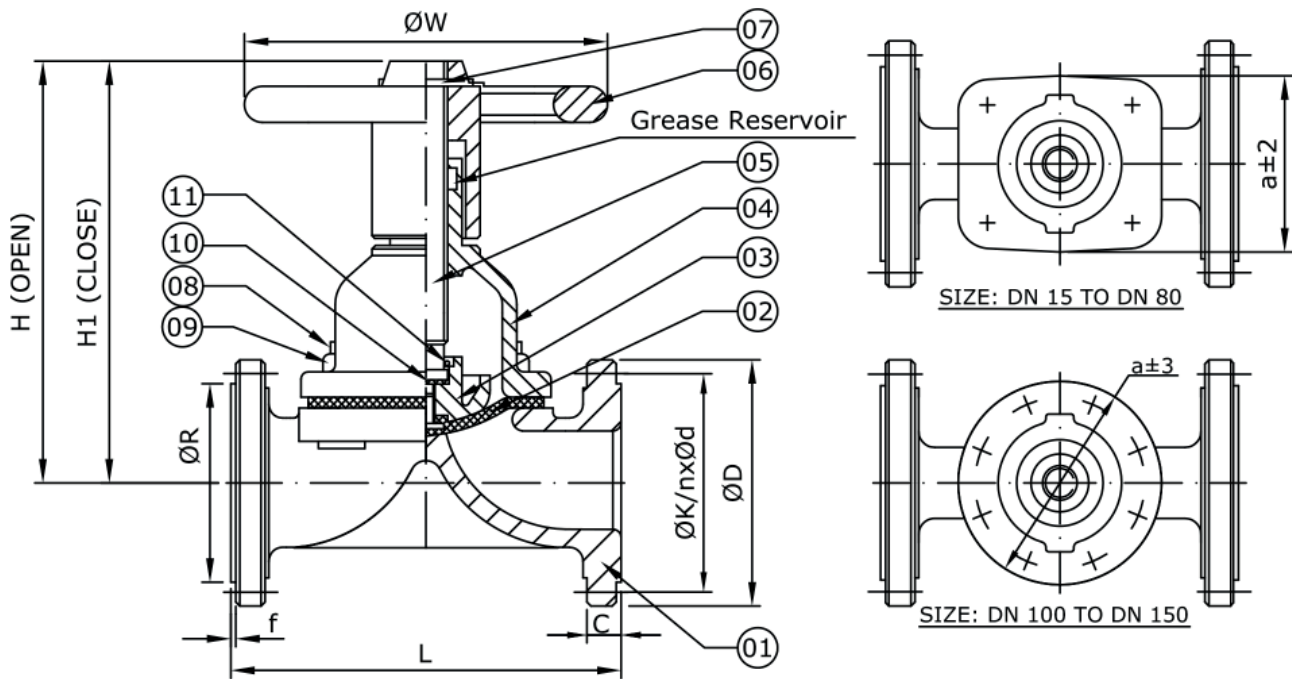

NO.	PART	MATERIAL
1	BODY	WCHL_ Cast iron EN-JL1040 (GG25) Halar® lined
		WDHL_ Ductile iron EN-JS1030 (GGG40)
2	DIAPHRAGM	RUBBER Natural (D10) / EPDM (D20) / Butyl (D30) / Nitrile (D40) / Neoprene (D50) / Hypalon (D60) / Viton (D70)
		PTFE + EPDM (D92) / PTFE + Butyl (D93) / PTFE + Viton (D97)
3	COMPRESSOR	Cast iron EN-JL1040 (GG25)
4	BONNET	WCHL_ Cast iron EN-JL1040 (GG25)
		WDHL_ Ductile iron EN-JS1030 (GGG40)

NO.	PART	MATERIAL
5	SPINDLE	Steel
6	HANDWHEEL	Cast iron EN-JL1040 (GG25)
7	H/W DOWEL PIN	Steel (EN42)
8	BODY STUDS	St. steel SS304
9	BODY NUTS	St. steel SS304
10	THRUST WASHER	Nylon
11	COMP. PIN	Steel (EN42)

Main Valve Parameters

	DN	15	20	25	32	40
L	EN 558 S7 (BS 5156)	108	114	127	146	159
	EN 558 S1 (DIN 3202 F1)	130	150	160	180	200
	H (open)	109	117	140	143	172
	H1 (close)	103	109	130	131	152
a		52	67	75	88	110
ØW		100	100	120	120	120
FLANGED ENDS TO EN PN10	ØD	95	105	115	140	150
	C	14	16	16	18	18
	ØR	45	58	68	78	88
	f	2	2	2	2	3
	nxØd	4x14	4x14	4x14	4x18	4x18
	ØK	65	75	85	100	110
FLANGED ENDS TO ASA150#*	ØD	89	98	108	117	127
	C	11,5	11,5	11,5	13	14,5
	ØR	35	43	51	64	73
	f	1,6	1,6	1,6	1,6	1,6
	nxØd	4x16	4x16	4x16	4x16	4x16
	ØK	60,3	69,8	79,4	88,9	98,4
Approx. Weight	EN 558 S7 (BS 5156)	2,3	3,2	4,2	6,4	7,5
	EN 558 S1 (DIN 3202 F1)	2,7	3,5	4,4	6,6	8,5

*Unless specific agreement with COMEVAL, valves with flanges 150# will be usually supplied as EN/DIN flanges with 150# drilling, since pressure is limited to EN/DIN Information / restriction of technical rules need to be observed! Installation, Operating and Maintenance Manual can be downloaded at www.comeval.es

Dimensions in mm subject to manufacturing tolerance / Weights in kg

The engineer, designing a system or a plant, is responsible for the selection of the correct valve Product suitability must be verified, contact manufacturer for information

Halar® coated valves with flanged ends

Main Valve Parameters

	DN	50	65	80	100	125	150
L	EN 558 S7 (BS 5156)	190	216	254	305	356	406
	EN 558 S1 (DIN 3202 F1)	230	290	310	350	400	480
	H (open)	190	230	242	326	391	468
	H1 (close)	166	195	202	275	326	390
	a	127	146	190	Ø230	Ø265	Ø320
	ØW	164	220	240	270	270	360
FLANGED ENDS TO EN PN10	ØD	165	185	200	220	250	285
	C	20	20	22	24	26	26
	ØR	102	122	138	158	188	212
	f	3	3	3	3	3	3
	nxØd	4x18	4x18	8x18	8x18	8x18	8x22
FLANGED ENDS TO ASA150#*	ØK	125	145	160	180	210	240
	ØD	152	178	191	229	254	279
	C	16	17,5	19,5	24	24	25,5
	ØR	92	105	127	157	186	216
	f	1,6	1,6	1,6	1,6	1,6	1,6
	nxØd	4x19	4x19	4x19	8x19	8x22	8x22
	ØK	120,6	139,7	152,4	190,5	215,9	241,3
Approx. Weight	EN 558 S7 (BS 5156)	12	18	23	34	50	69
	EN 558 S1 (DIN 3202 F1)	12,5	19	25	36	52	75

*Unless specific agreement with COMEVAL, valves with flanges 150# will be usually supplied as EN/DIN flanges with 150# drilling, since pressure is limited to EN/DIN

Dimensions in mm subject to manufacturing tolerance / Weights in kg